

DSR-V Series Roots Vacuum Blower

Product Introduce

Roots Blower

High efficiency tri-lobe rotor,
quiet running, small outline,
easy maintenance, low vibration.



DICHENG DSR-V Series Roots Vacuum Blowers adopts the advanced technology of Japan, its air capacity is 0.86m³/min - 58.65m³/min, the vacuum pressure is from -13.3Kpa to -40Kpa. The main characteristic of our air blower is small volume, light weight, flow strong, noise small, steadily reliable operation. This air blower is mainly applied to such trades as water treatment, air transport, mine, vacuum packaging, aquaculture and etc. Our products export to Southeast Asia, Europe, North and South America and etc.

Product Feature



1. Air flow and pressure can be customized
2. Stable air flow and less pressure variation
3. Clean air not with oil moist
4. Construction simple and easy maintenance
5. Bearing are all lubricated by oil moist
6. Long service life

Blower Selection

DSR-V Roots Vacuum Pump

DSR50V	0.86-2.46m ³ /min	9.8-40Kpa
DSR65V	1.45-3.57m ³ /min	9.8-40Kpa
DSR80V	2.5-5.53m ³ /min	9.8-40Kpa
DSR100V	3.57-9.08m ³ /min	9.8-40Kpa
DSR125V	5.14-12.50m ³ /min	9.8-40Kpa
DSR150V	11.60-27.80m ³ /min	9.8-40Kpa
DSR200V	27.08-58.65m ³ /min	9.8-40Kpa



Blower Structure Diagram

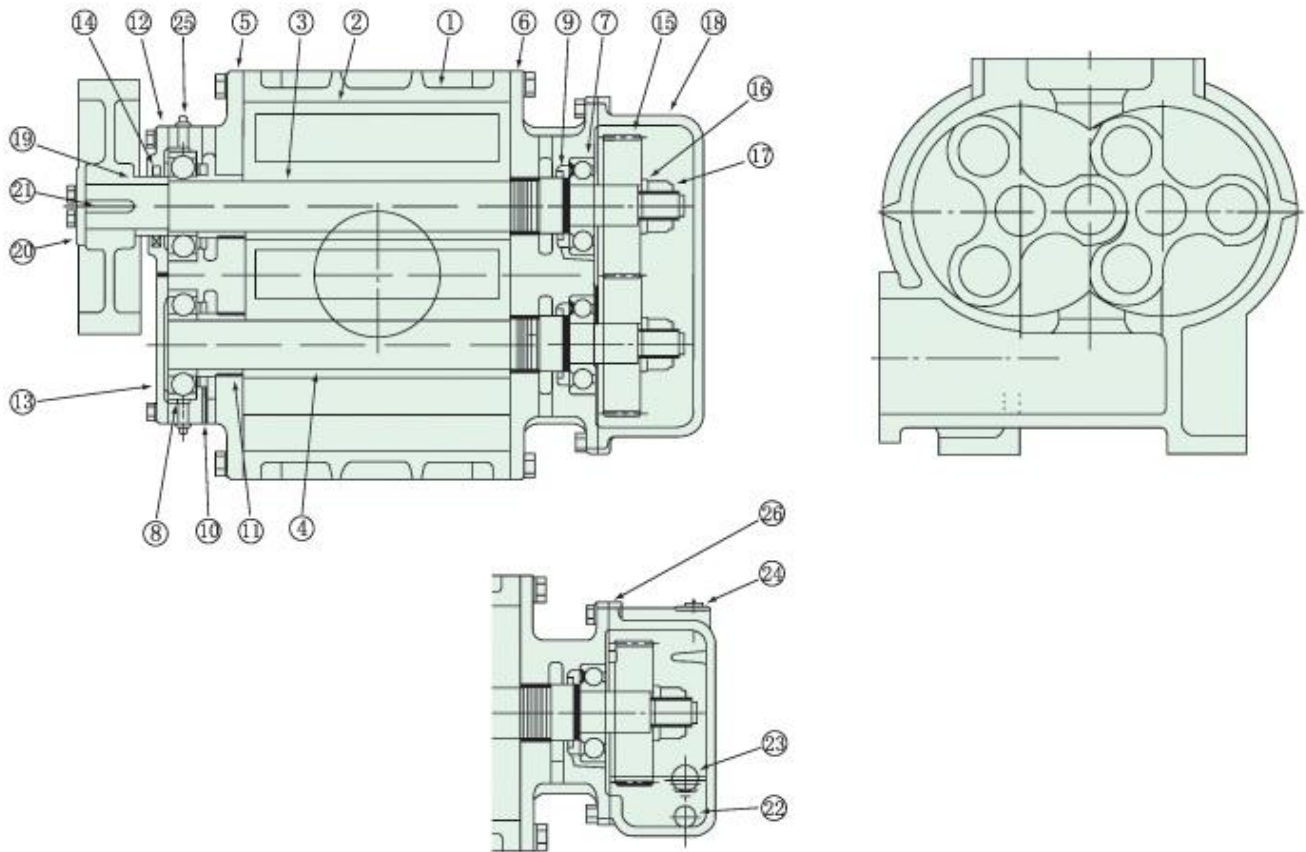

No.	Name	Material	Q' ty	No.	Name	Material	Q' ty
1	Shell	HT200	1	14	Z sealing ring	Nitrile rubber	1
2	Impeller	HT200	2	15	Gear	35CrM	2
3	Drive shaft	45Cr	1	16	Gear lock washer	Q235	2
4	Driven shaft	45Cr	1	17	Gear lock nut	SS400	2
5	Drive side siding	HT200	1	18	Gearbox	HT200	1
6	Gear side siding	HT200	1	19	Sleeve	45	1
7	Drive bearing	NSK	2	20	End cover	Q235	2
8	Driven bearing	NSK	2	21	Pin	45	1
9	Sealing ring	Nitrile rubber	2	22	Plug	35	1
10	Sealing ring	Nitrile rubber	2	23	Oil gauge		1
11	Bearing sleeve	45	4	24	Vent		1
12	Bearing cover	HT200	1	25	Grease nipple	C3605	2
13	Bearing cover	HT200	1	26	Gearbox seals	Barley paper	2

Outline drawings and foundation installation

DSR Roots blower (Belt drive)

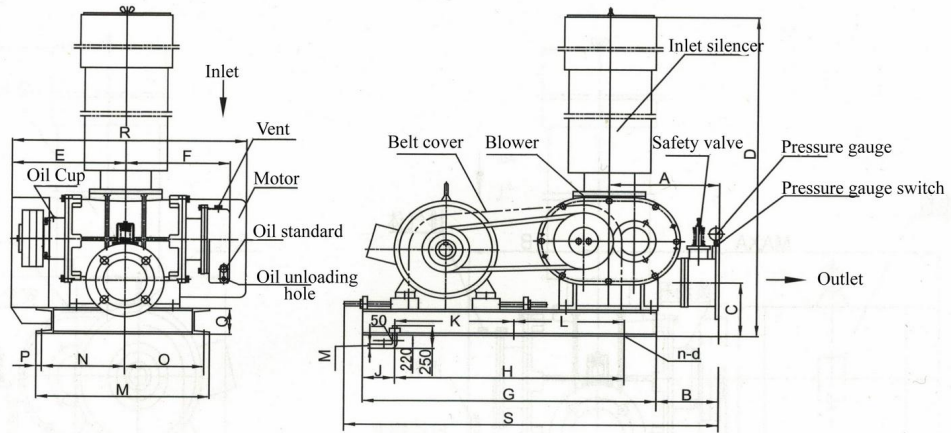

Anchor bolts layout

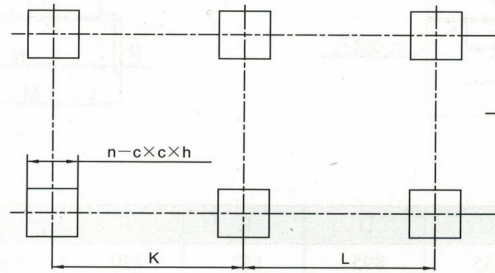

	A	B	C	D	E	F	G	H	J	K	L	n-cxhx
DSR -50	260	160	130	875	190	185	560	410	75	---	---	4-150x150x 280
DSR -65	260	160	130	945	210	207	600	450	75	---	---	
DSR -80	300	190	145	1107	225	220	650	500	75	---	---	
DSR -100	300	190	155	1232	265	260	730	580	75	---	---	
DSR -125	345	195	190	1435	280	265	870	700	80	350	350	6-150x150x 280
DSR -150	410	245	210	1725	375	355	960	750	105	400	350	
DSR -175	410	245	265	1756	495	475	1100	850	160	450	400	
DSR -200	480	265	256	2203	500	455	1280	1000	140	500	400	8-180x180x 280
DSR -250	755	415	370	2905	590	580	1860	1500	180	750	750	
DSR -300	755	405	420	2945	695	680	2070	1500	240	750	750	
	M	N	O	P	Q	M	R	S	I	Weight (kg)		n-d
DSR -50	300	112	152	18	80	M16	450	730	265	70		4-φ 18
DSR -65	340	132	175	18	80		500	780	304	81		
DSR -80	360	127	197	18	80		530	860	324	123		
DSR -100	470	167	267	18	80		600	930	434	157		
DSR -125	470	180	256	20	100		710	1230	430	235		6-φ 18
DSR -150	590	255	295	20	100		860	1335	540	394		
DSR -175	820	375	405	20	120		995	1335	850	443		
DSR -200	755	360	345	24	126		1080	1765	1000	860		
DSR -250	1100	375	655	35	160	M20	1165	2400	1500	1629		6-φ 22
DSR -300	1310	480	760	35	180		1166	2400	1500	2118		

DSR Roots blower (Coupling drive)

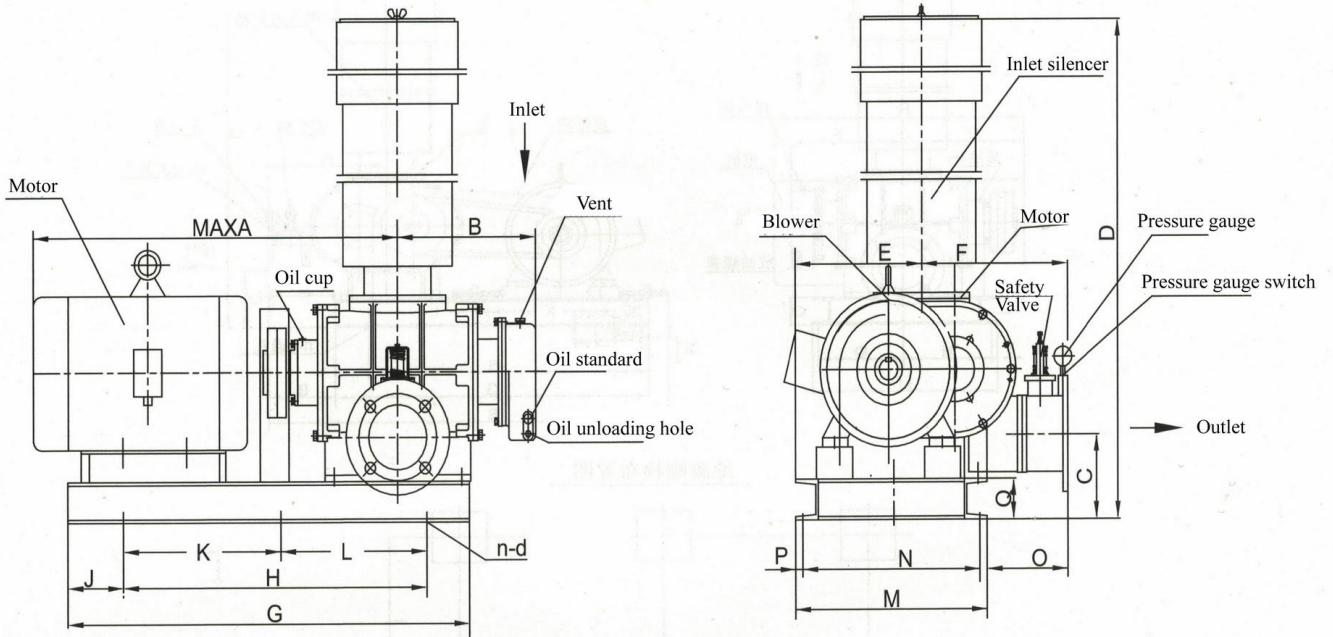

	A	B	C	D	E	F	G	H	J
DSR -50	570	179	135	895	152	230	540	420	60
DSR -65	610	202	145	970	192	230	600	440	80
DSR -80	700	225	165	1130	217	280	650	500	75
DSR -100	900	265	175	1255	234	280	850	630	110
DSR -125	945	294	205	1525	260	345	920	710	105
DSR -150	1155	377	225	1745	305	385	1150	950	100
DSR -175	1400	470	265	1610	390	400	1500	1200	150
DSR -200	1570	550	276	2230	405	593	1600	1300	150
DSR -250	1847	596	370	2570	520	680	2200	1800	200
DSR -300	2167	683	470	2820	520	670	2000	2500	250
	K	L	M	N	O	P	Q	Weight (kg)	n-d
DSR -50	---	---	260	220	122	20	80	70	4- φ 18
DSR -65			300	260	122	20	80	81	
DSR -80			370	330	147	20	80	123	
DSR -100	---	---	400	360	114	20	80	157	
DSR -125			430	390	175	20	100	235	6- φ 18
DSR -150	475	475	500	455	190	22.5	100	394	
DSR -175	600	600	690	640	215	25	120	443	
DSR -200	650	650	650	605	348	22.5	126	860	6- φ 22
DSR -250	900	1000	1030	950	250	40	160	1629	
DSR -300	1000	1000	1030	950	240	40	180	2118	

DSR-HB-U Roots blower (Belt drive)

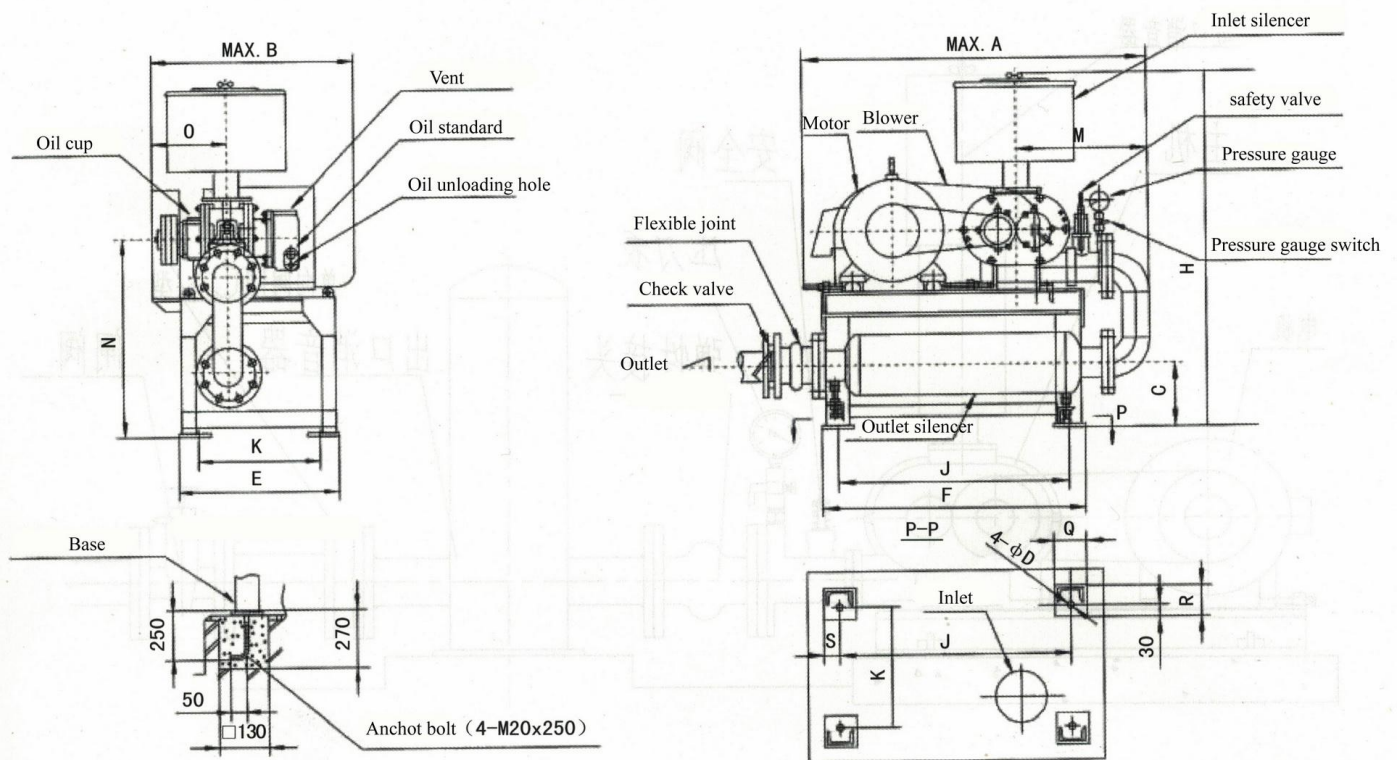

Model	A	B	C	E	F	H	J	K
DSR-50H-U	940	460	170	380	680	945	600	240
DSR-65H-U	1020	540	190	395	720	990	640	255
DSR-80H-U	1130	690	200	500	840	1120	760	360
DSR-100H-U	1430	760	225	555	1030	1200	950	375
DSR-125HB-U	1700	825	240	575	1220	1395	1140	395
DSR-150HB-U	1795	1055	260	740	1260	1650	1180	560
DSR-200HB-U	2200	1240	320	830	1670	1815	1590	650
Model	M	N	O	Q	R	S	4-φD	Weight (kg)
DSR-50H-U	345	520	185	100	100	40	4-φ23	173
DSR-65H-U	375	565	205	100	100	40	4-φ23	216
DSR-80H-U	420	625	235	100	100	40	4-φ23	340
DSR-100H-U	450	700	290	120	120	40	4-φ23	448
DSR-125HB-U	560	785	375	140	120	40	4-φ23	623
DSR-150HB-U	645	890	475	140	120	40	4-φ23	1130
DSR-200HB-U	915	995	605	140	120	40	4-φ23	2088

Note: The weight is including the weight of motor.

Pipe installation reference drawing

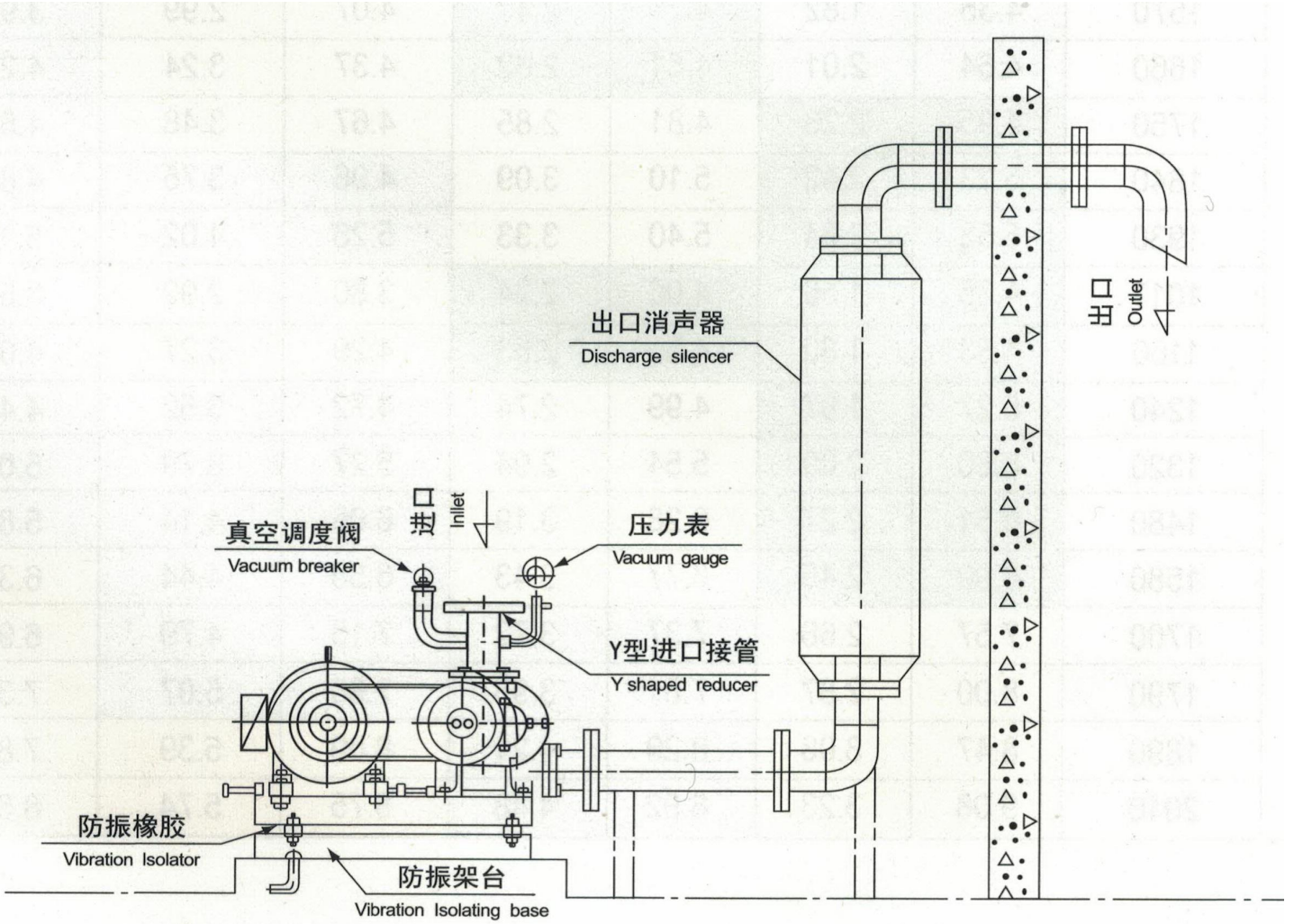

Blower Accessorie

Inlet silencer

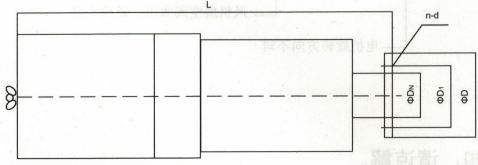
	Model	Dn	D1	D	L	N-Φh	Weight (Kg)
	XF-40	Φ40	85	110	220	4-Φ14	4
XF-50	Φ50	85	150	500	4-Φ14	5	
XF-65	Φ65	110	155	550	4-Φ14	7	
XF-80	Φ80	130	180	800	4-Φ14	15	
XF-100	Φ100	145	207	850	8-Φ18	19	
XF-125	Φ125	165	260	915	8-Φ18	22	
XF-150	Φ150	200	260	1100	8-Φ18	35	
XF-200	Φ200	280	320	1450	8-Φ20	60	
XF-250	Φ250	350	395	1650	12-Φ20	120	
XF-300	Φ300	400	445	1750	12-Φ22	140	

Outlet silencer

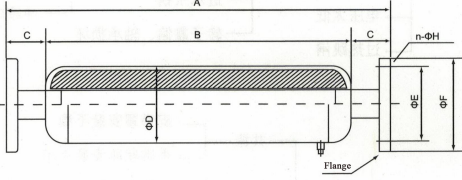
	Model	ΦE	A	B	C	D	N-Φh	Weight (Kg)
	KM-40	Φ40	500	135	110	150	4-Φ19	9
KM-50	Φ50	600	140	125	165	4-Φ19	12	
KM-65	Φ65	700	165	145	185	4-Φ19	16	
KM-80	Φ80	900	190	160	200	8-Φ19	20	
KM-100	Φ100	1200	217	180	220	8-Φ19	38	
KM-125	Φ125	1400	261	210	250	8-Φ22	45	
KM-150	Φ150	1600	286	240	285	8-Φ22	68	
KM-200	Φ200	1800	320	295	310	8-Φ22	85	
KM-250	Φ250	2000	450	350	395	12-Φ22	130	
KM-300	Φ300	2000	500	400	445	12-Φ22	160	

Vertical outlet silencer

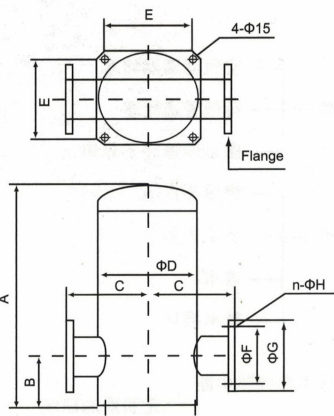



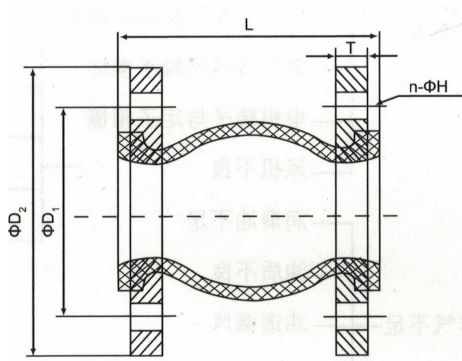



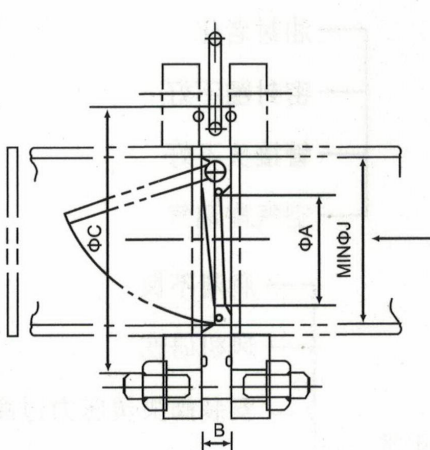

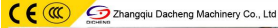





	Model	ΦF	A	B	C	D	E	F	G	N-Φh	Weight (Kg)
	RKM-40	Φ40	350	90	125	145	125	110	150	4-Φ18	10
RKM-50	Φ50	450	130	140	165	140	125	165	4-Φ19	15	
RKM-65	Φ65	500	140	170	190	170	145	185	4-Φ19	20	
RKM-80	Φ80	610	150	190	217	190	160	200	8-Φ19	27	
RKM-100	Φ100	680	160	220	261	220	180	220	8-Φ19	34	
RKM-125	Φ125	820	200	240	286	240	210	250	8-Φ22	58	
RKM-150	Φ150	940	220	290	370	290	240	285	8-Φ22	80	
RKM-200	Φ200	1060	260	320	420	320	295	340	8-Φ22	97	
RKM-250	Φ250	1250	400	350	500	500	350	395	12-Φ22	140	
RKM-300	Φ300	1300	430	560	560	560	400	445	12-Φ22	180	

Flexible joint

	Model	Φ	D1	D2	L	T	N-Φh	Weight (Kg)
	KXT-40	Φ40	110	150	90	16	4-Φ18	2
	KXT-50	Φ50	125	165	105	18	4-Φ19	3
	KXT-65	Φ65	145	185	115	20	4-Φ19	3.5
	KXT-80	Φ80	160	200	135	20	8-Φ19	4
	KXT-100	Φ100	180	220	150	22	8-Φ19	5
	KXT-125	Φ125	210	250	165	24	8-Φ19	6.5
	KXT-150	Φ150	240	285	180	24	8-Φ22	9.5
	KXT-200	Φ200	295	340	190	24	8-Φ22	16
	KXT-250	Φ250	350	395	230	24	12-Φ22	25
KXT-300	Φ300	400	445	245	24	12-Φ22	38	

Check valve

	Model	Φ	A	B	C	J	Weight (Kg)
	DCV-40	Φ40	20	16	90	40	1.0
	DCV-50	Φ50	25	19	105	50	1.2
	DCV-65	Φ65	36	19	125	65	1.5
	DCV-80	Φ80	46	19	135	80	1.8
	DCV-100	Φ100	67	19	160	100	2.5
	DCV-125	Φ125	88	21	190	125	3.6
	DCV-150	Φ150	108	24	220	150	5.2
	DCV-200	Φ200	138	29	270	200	11.0
	DCV-250	Φ250	200	30	330	250	15.0
DCV-300	Φ300	240	40	380	300	22.0	

 	 	 	 	 
Silencer	Shell	Siding	OPT belt	Shaft
 	 	 	 	 
Impeller	NSK bearing	Check valve	Flexible joint	Package

Noise test results

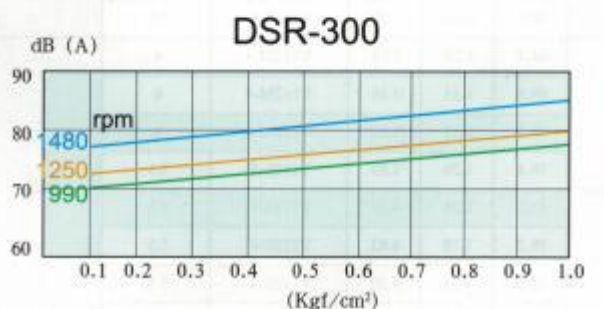
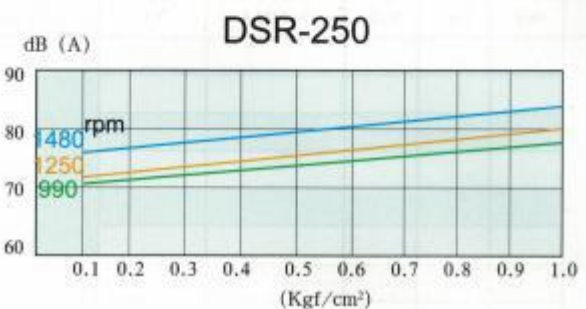
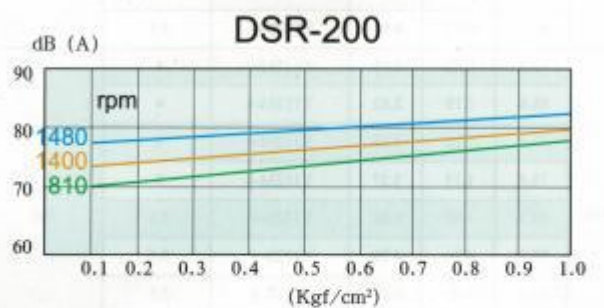
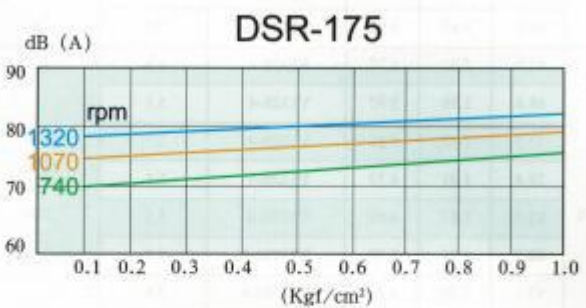
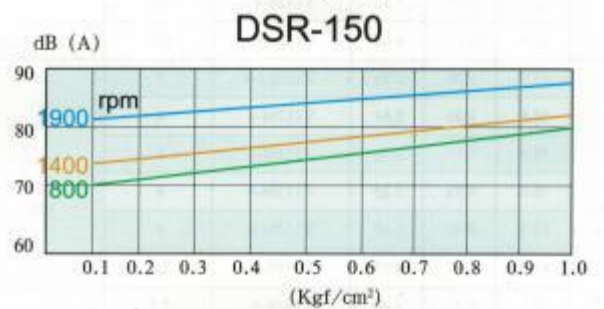
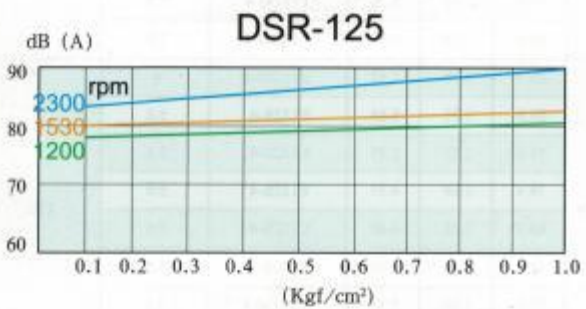
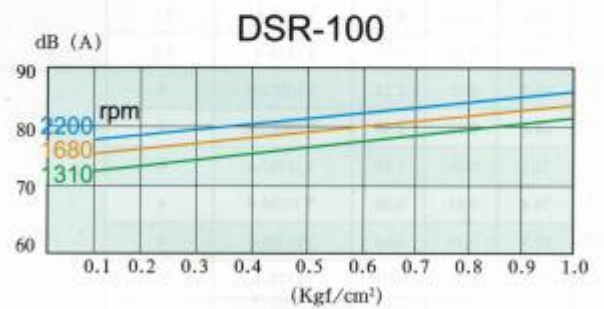
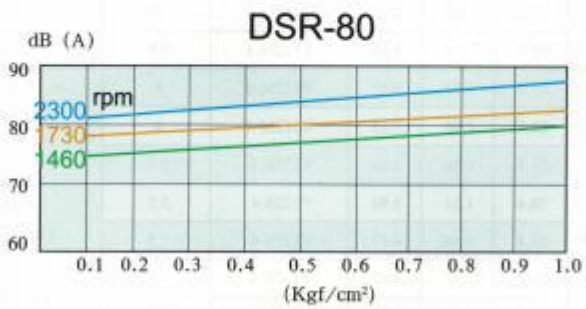
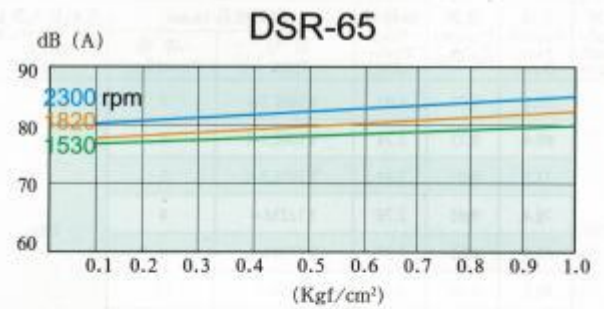
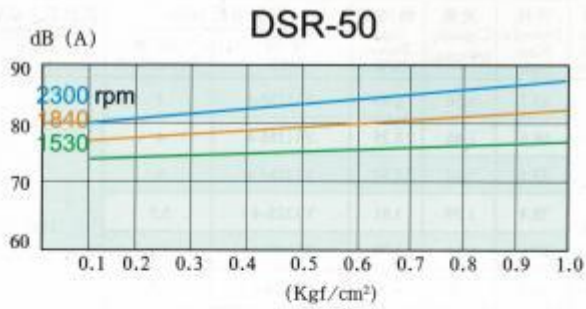

Note:

- 1: The noise test result is tested at a distance of 1 meter from the blower.
- 2: The noise level is affected by the length of the line, the number of turns and the surrounding environment.

Common malfunctions and Solution

Malfunctions		Reason	Solution		
Blower	Can not rotate	Can rotated by hand	The motor is damaged	Repair or replace the motor	
		Can rotated round by hand	The lobes are locked	Open to repair	
			The impurity in blower	Open to clean	
	Abnormal sound or vibration	Can rotate	Skid, v-belt is too tight or too loose	Adjust v-belt tension	
			Pulley offset	Reset pulley	
			Pulley and belt cover friction	Adjust belt cover	
			Bearing oil lack or aging	To replace the oil	
			Gear oil lack or aging	To replace the oil	
			The safe valve leakage	Adjust the safe valve	
			Foundation insufficient strength	To strengthen the foundation strength	
			Piping resonance	Eliminate by the silencer and support	
			Exhaust pressure rises abruptly	See ※annotated	
			Anchor bolt is too loose	Tighten	
			Rotor interference	Open to repair	
			The impurity in blower	Open to clean	
			Check valve bad	Replace	
			Overheating	Exhaust pressure rises abruptly	See ※annotated
				Temperature of working environment exceeds 40 °C	Ventilated working environment
	Inlet silencer obstruction	Cleaning/replace filter			
	Airflow insufficient	Pipeline leaks	Tighten the pipe connection		
		Inlet silencer obstruction	Cleaning/replace filter		
		The safe valve leakage	Adjust the safe valve		
		V-belt is too loose	Adjust v-belt tension		
		Exhaust pressure rises abruptly	See ※annotated		
	Exhaust pressure rises abruptly	Shut off the valve	Fully open the valve		
		The water level rises	Adjust water level		
		Inlet/outlet pipe jams	Cleaning debris		
		Valve bad or twist reversed direction	Replace or reverse direction twist		
		Airflow overpowered	Reduce round speed or exhaust		
	Oil leak	Can rotate	Lubrication oil overmuch	Refuel to the center of oil standard	

FAQ

1. What's the information should I provide when inquiry?

A: Air capacity

B: Pressure

C: Application

D: Use environment(Temperature, atmospheric pressure)

E: Do you need motor?

Or other specials you give us will be more appreciated.

2. What is your warranty?

Our warranty is 12 months after received the roots blower. During the warranty period, replace the damaged parts for free of charge. Out warranty period, to provide timely, high-quality technical services and price concessions spare parts to ensure continuous safe and high-quality equipment operation.

3. How long is the service life of roots blower?

In normal use environment

A- Service life of blower is more than 10 years.

B- Service life of Impeller is more than 60,000 hours.

C- Service life of bearing is more than 30,000 hours.

D- Service life of gear is more than 60,000 hours.

Contact Us

Shandong Dacheng Machinery Technology Co., LTD

Address: Zhangqiu Mingshui, Jinan City, Shandong province, China 250200.

Website: <http://www.chinadicheng.com>

Tel: +86 0531-83216898

Fax: +86 0531-83216898

Cellphone: +86 013188890202

WhatsApp: +86 013188890202

Skype: <live:zqdicheng>

Email: zqdicheng@chinadicheng.com